

Please print the document at 100% for an accurate scale results.

# TAYLOR MADE: STANDARD

Design your own seating arrangement with Taylor Made. Arrange it to suit your specific needs, and select your favorite back cushion, arm and base styles. In just five easy steps, you have a custom sectional, sofa, loveseat or chair that's uniquely your own.

## STEP 1 STANDARD DEPTH:

STANDARD - DEPTH 39.5"

**SOFA, LOVESEAT AND CHAIRS / SECTIONAL PIECES:**  
 Overall height-38" / Overall depth-39.5"  
 Inside depth-22" / Arm height-24.5" / Seat height-21.5"  
 19" Throw Pillows. No pillows standard on leather.  
 Upholstered base versions (-7) and (-8) available in leather.  
 1/2" nails are standard on leather.

## STEP 2 CHOOSE YOUR BACK: LOOSE STANDARD / SEMI-ATTACHED OPTIONAL



44 SQUARE BOX BORDER BACK



45 ROUND BOX BORDER BACK

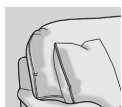

46 KNIFE EDGE BORDER BACK



47 BOX BORDER BACK / NO "T" SHAPE

## STEP 3 CHOOSE YOUR SEATING: YOUR CHOICE OF OTTOMAN, CHAIR, LOVESEAT AND SOFA

Quarter Inch Scale Drawing



4500-0 CORRELATING OTTOMAN FOR -38 H20" D23" W31"



4501-0 BUMPER OTTOMAN H21.5" D23" W31"



4502-0 SQUARE BUMPER OTTOMAN H21.5" D29" W29"



4590-0 CORRELATING OTTOMAN FOR -52 H20" D27" W47"



-38 CHAIR W38"

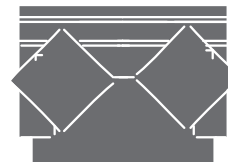

-52 CHAIR & A HALF W52"

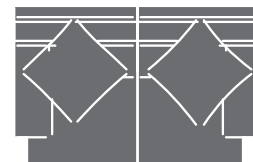

-60 TWO CUSHION LOVESEAT W60"

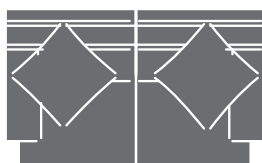

-64 TWO CUSHION LOVESEAT W64"



-68 TWO CUSHION LOVESEAT W68"



-72 TWO CUSHION MINI SOFA W72"

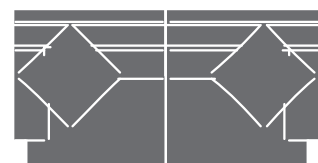

-76 TWO CUSHION MINI SOFA W76"



-80 TWO CUSHION SOFA W80"

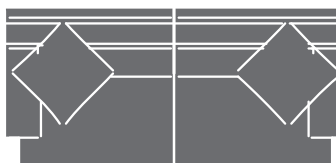

-84 TWO CUSHION SOFA W84"

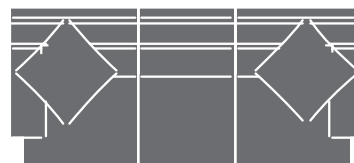

-88 THREE CUSHION SOFA W88"

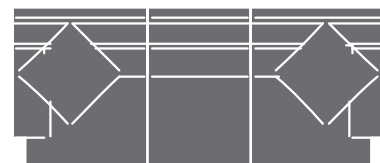

-92 THREE CUSHION SOFA W92"

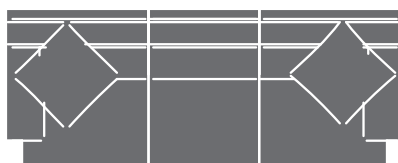

-96 THREE CUSHION SOFA W96"



-112 FOUR CUSHION SOFA W112"

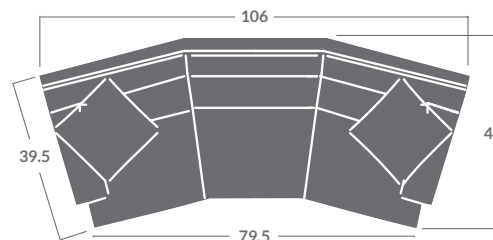

-106 CONVERSATION SOFA W106"

# STEP 3 CHOOSE YOUR SEATING: YOUR CHOICE OF SECTIONAL PIECES

Quarter Inch Scale Drawing



-10  
ARMLESS CHAIR  
W24"



-11  
LEFT ARM CHAIR  
W33"



-12  
RIGHT ARM CHAIR  
W33"



-15  
CORNER CHAIR  
W39.5"



-20  
ARMLESS LOVESEAT  
W48"



4500-2  
CORRELATING OTTOMAN FOR  
-25 QUARTER TURN ONLY  
H20" D32" W53"

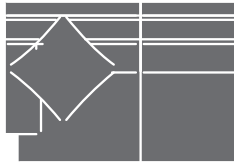

-21  
LEFT ARM LOVESEAT  
W57"

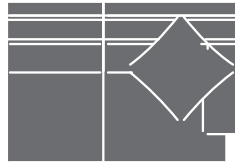

-22  
RIGHT ARM LOVESEAT  
W57"



-30  
ARMLESS SOFA  
W72"



-41  
LEFT ARM  
CHAISE  
W33" D63"



-42  
RIGHT ARM  
CHAISE  
W33" D63"

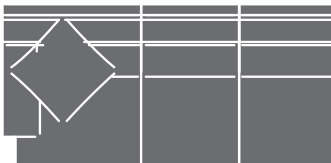

-31  
LEFT ARM SOFA  
W81.5"



-32  
RIGHT ARM SOFA  
W81.5"



-45  
LEFT ARM  
CHAISE  
W40" D63"



-46  
RIGHT ARM  
CHAISE  
W40" D63"

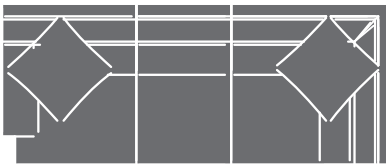

-33  
LEFT ARM CORNER SOFA  
W95.5"

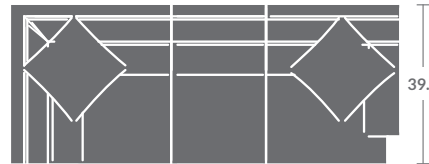

-34  
RIGHT ARM CORNER SOFA  
W95.5"



-49  
LEFT OPEN END CORNER SOFA  
W93"



-50  
RIGHT OPEN END CORNER SOFA  
W93"



-61  
LEFT OPEN END LOVESEAT  
W53.5"



-62  
RIGHT OPEN END LOVESEAT  
W53.5"

# STEP 3 CHOOSE YOUR SEATING: YOUR CHOICE OF SECTIONAL PIECES *(continued)*

Quarter Inch Scale Drawing

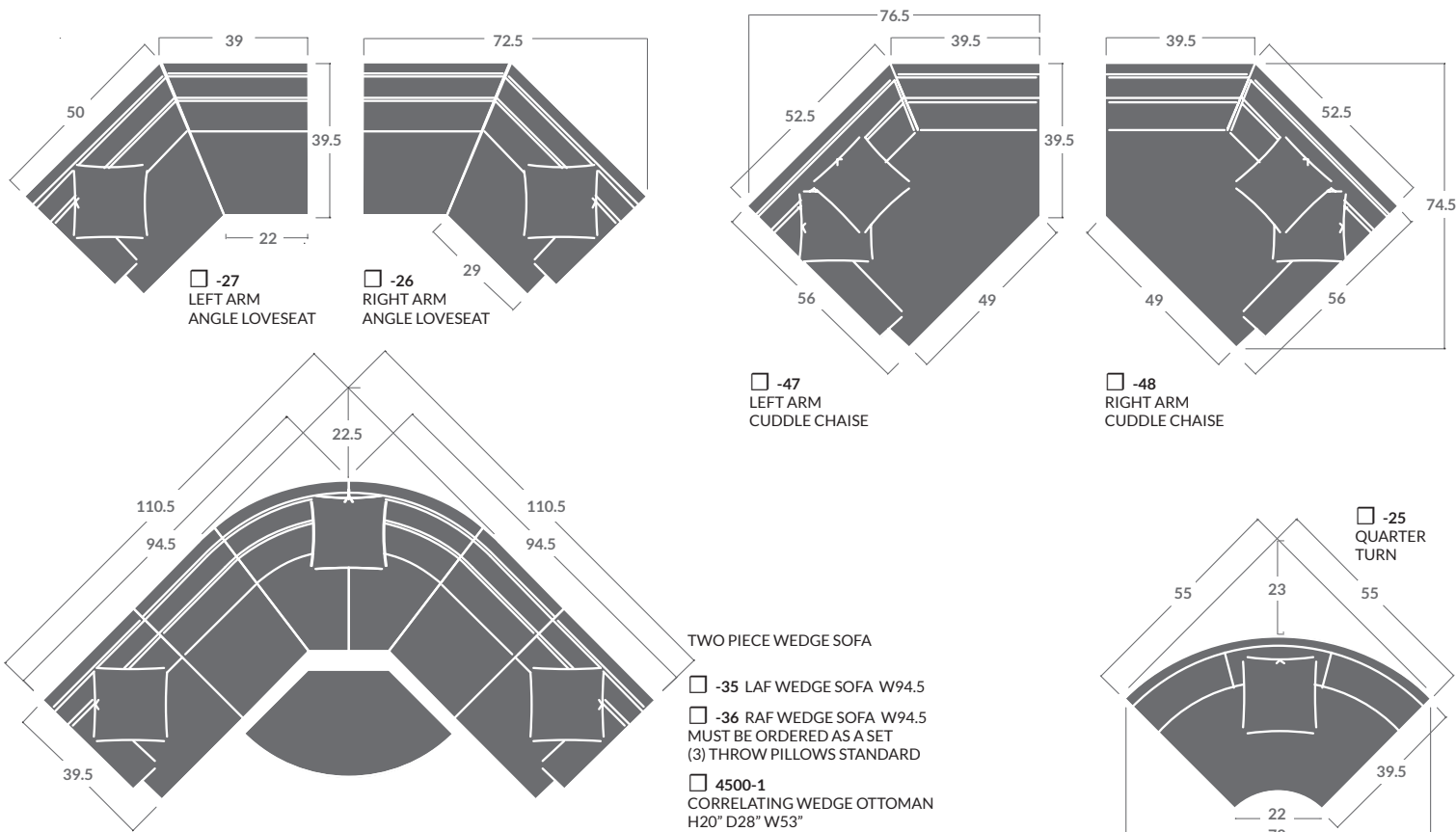

## STEP 4 CHOOSE YOUR ARM:

TRACK ARM - CHAIR 5"/SOFA 6"  
 ENGLISH ARM - CHAIR 6.5"/SOFA 7.5"  
 ALL OTHERS - CHAIR 7.5"/SOFA 8.5"

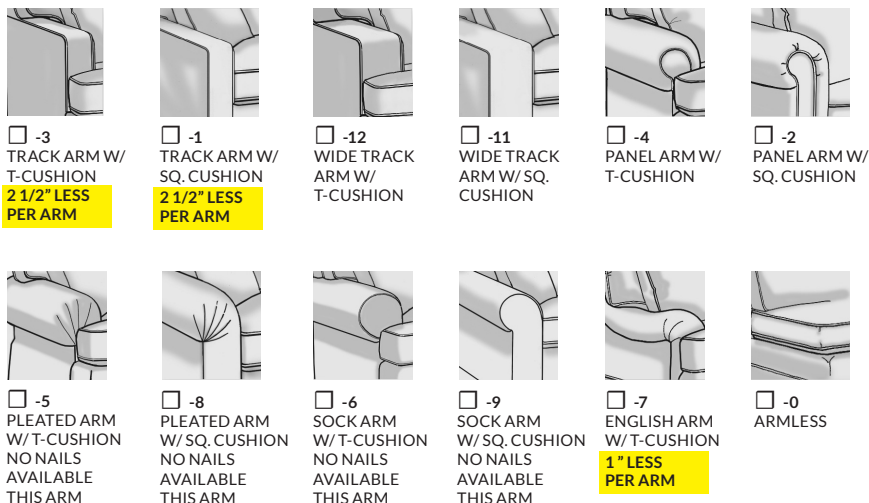

## STEP 5 CHOOSE YOUR BASE STYLE:

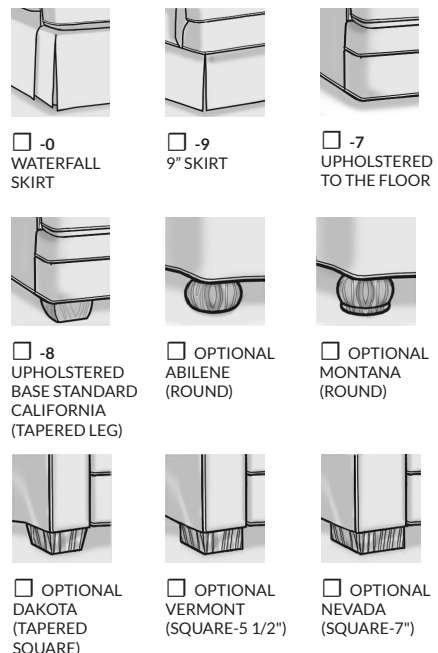

Please print the document at 100% for an accurate scale results.

# TAYLOR MADE: PLUSH

Design your own seating arrangement with Taylor Made. Arrange it to suit your specific needs, and select your favorite back cushion, arm and base styles. In just five easy steps, you have a custom sectional, sofa, loveseat or chair that's uniquely your own.

## STEP 1 PLUSH DEPTH:

PLUSH - DEPTH 41.5"

### SOFA, LOVESEAT AND CHAIRS / SECTIONAL PIECES:

Overall height-38" / Overall depth-41.5"  
 Inside depth-24" / Arm height-24.5" / Seat height-21.5"  
 19" Throw Pillows - Arms & Corners  
 21" Throw Pillows - Arms Only  
 No pillows standard on leather.  
 Upholstered base versions (-7) and (-8) available in leather.  
 1/2" nails are standard on leather.

## STEP 2 CHOOSE YOUR BACK: LOOSE STANDARD / SEMI-ATTACHED OPTIONAL



44 SQUARE BOX BORDER BACK



45 ROUND BOX BORDER BACK



46 KNIFE EDGE BORDER BACK



47 BOX BORDER BACK / NO "T" SHAPE

## STEP 3 CHOOSE YOUR SEATING: YOUR CHOICE OF OTTOMAN, CHAIR, LOVESEAT AND SOFA

Quarter Inch Scale Drawing



4500-0 CORRELATING OTTOMAN FOR -38 H20" D23" W31"



4501-0 BUMPER OTTOMAN H21.5" D23" W31"



4502-0 SQUARE BUMPER OTTOMAN H21.5" D29" W29"



4590-0 CORRELATING OTTOMAN FOR -52 H20" D27" W47"



-38 CHAIR W38"

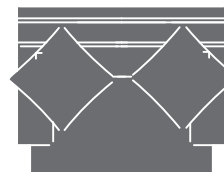

-52 CHAIR & A HALF W52"

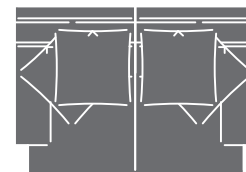

-60 TWO CUSHION LOVESEAT W60"

41.5

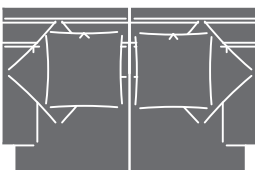

-64 TWO CUSHION LOVESEAT W64"

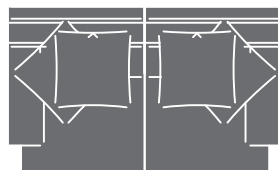

-68 TWO CUSHION LOVESEAT W68"

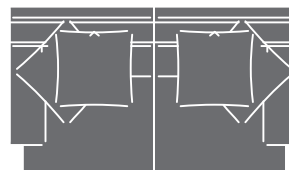

-72 TWO CUSHION MINI SOFA W72"

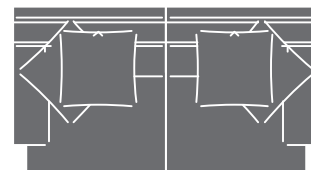

-76 TWO CUSHION MINI SOFA W76"

41.5

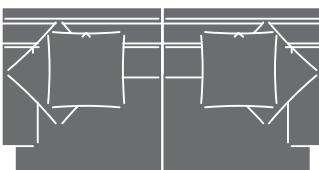

-80 TWO CUSHION SOFA W80"

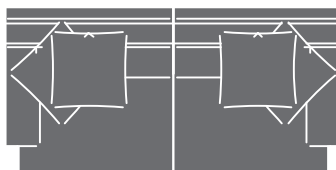

-84 TWO CUSHION SOFA W84"



-88 THREE CUSHION SOFA W88"

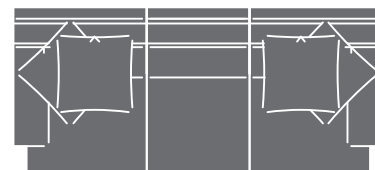

-92 THREE CUSHION SOFA W92"

41.5



-96 THREE CUSHION SOFA W96"



-112 FOUR CUSHION SOFA W112"

41.5

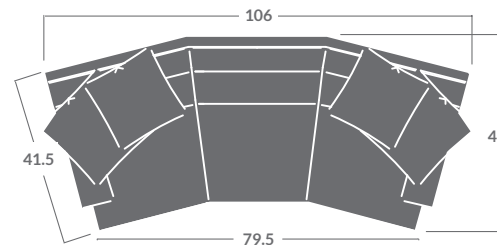

-106 CONVERSATION SOFA W106"

# STEP 3 CHOOSE YOUR SEATING: YOUR CHOICE OF SECTIONAL PIECES

Quarter Inch Scale Drawing



-10  
ARMLESS CHAIR  
W24"



-11  
LEFT ARM CHAIR  
W33"



-12  
RIGHT ARM CHAIR  
W33"



-15  
CORNER CHAIR  
W41.5"

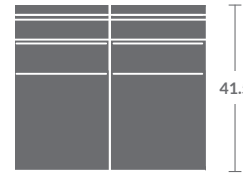

-20  
ARMLESS LOVESEAT  
W48"



4500-2  
CORRELATING OTTOMAN FOR  
-25 QUARTER TURN ONLY  
H20" D32" W53"

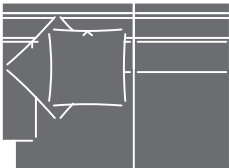

-21  
LEFT ARM LOVESEAT W57"

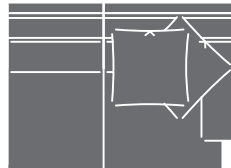

-22  
RIGHT ARM LOVESEAT W57"

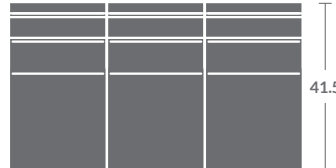

-30  
ARMLESS SOFA W72"



-41  
LEFT ARM  
CHAISE  
W33" D65"



-42  
RIGHT ARM  
CHAISE  
W33" D65"

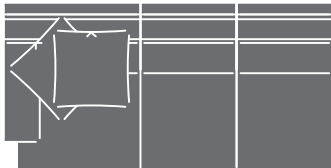

-31  
LEFT ARM SOFA W81"

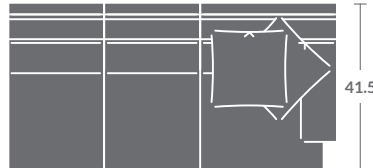

-32  
RIGHT ARM SOFA W81"



-45  
LEFT ARM  
CHAISE  
W40" D65"



-46  
RIGHT ARM  
CHAISE  
W40" D65"



-33  
LEFT ARM CORNER SOFA W97.5"



-34  
RIGHT ARM CORNER SOFA W97.5"



-49  
LEFT OPEN END CORNER SOFA  
W95"



-50  
RIGHT OPEN END CORNER SOFA W95"



-61  
LEFT OPEN END LOVESEAT  
W53.5"



-62  
RIGHT OPEN END LOVESEAT  
W53.5"

# STEP 3 CHOOSE YOUR SEATING: YOUR CHOICE OF SECTIONAL PIECES (continued)

Quarter Inch Scale Drawing

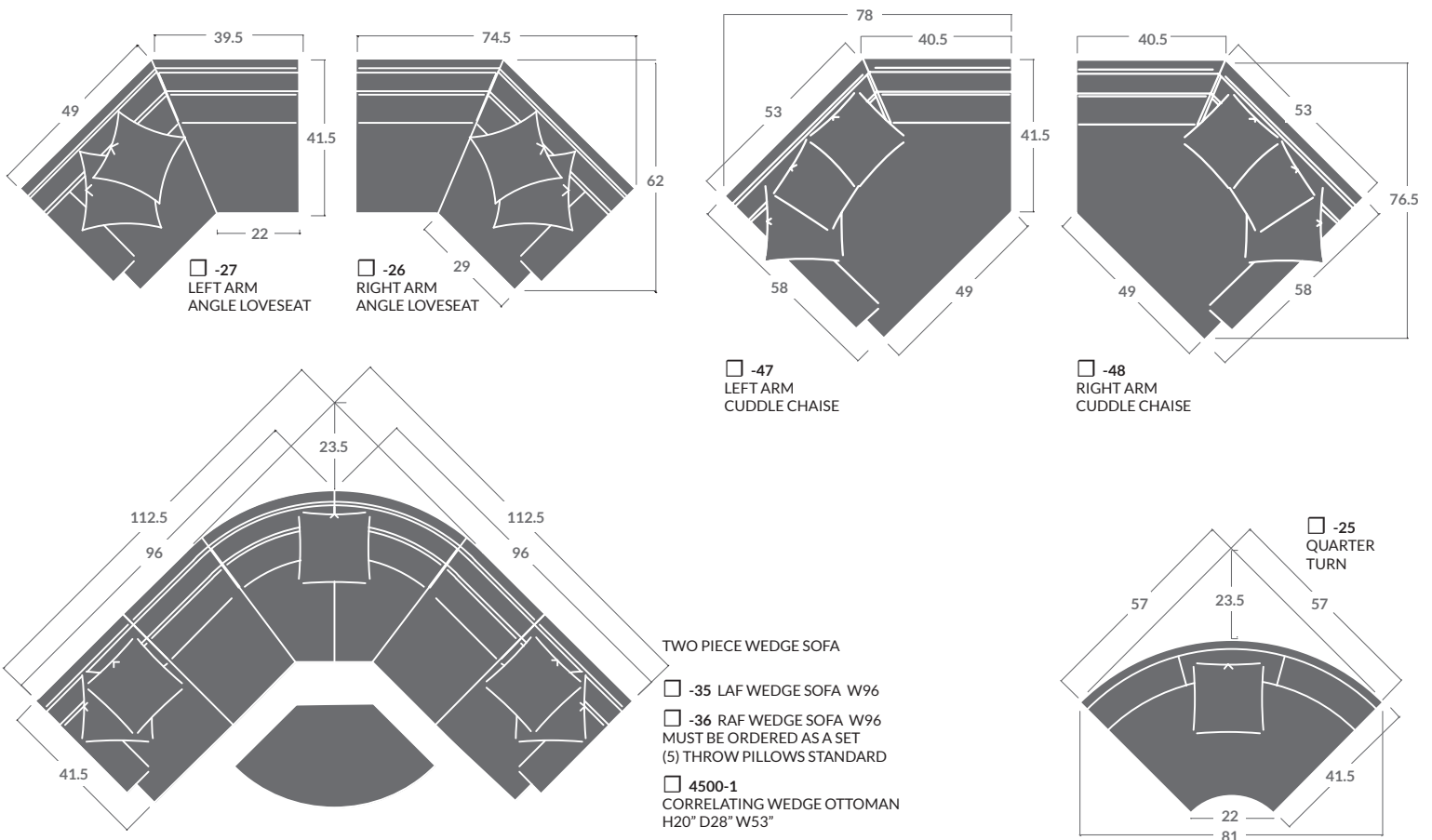

# STEP 4 CHOOSE YOUR ARM:

TRACK ARM - CHAIR 5"/SOFA 6"  
 ENGLISH ARM - CHAIR 6.5"/SOFA 7.5"  
 ALL OTHERS - CHAIR 7.5"/SOFA 8.5"

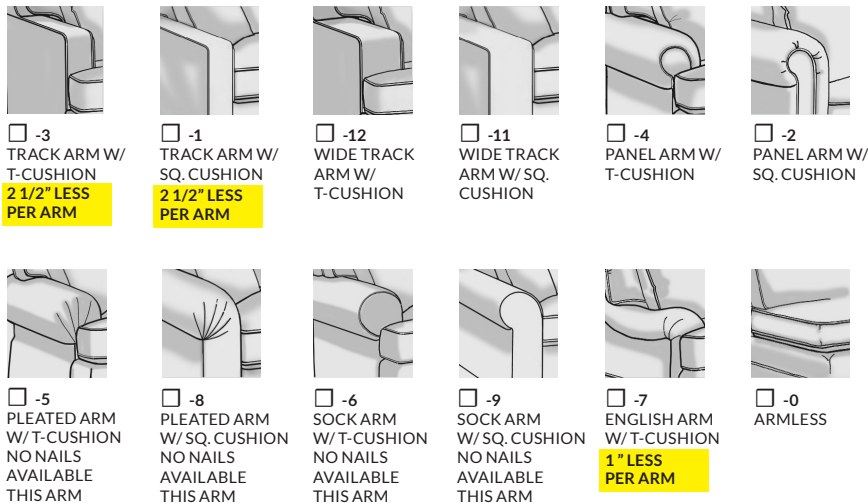

# STEP 5 CHOOSE YOUR BASE STYLE:

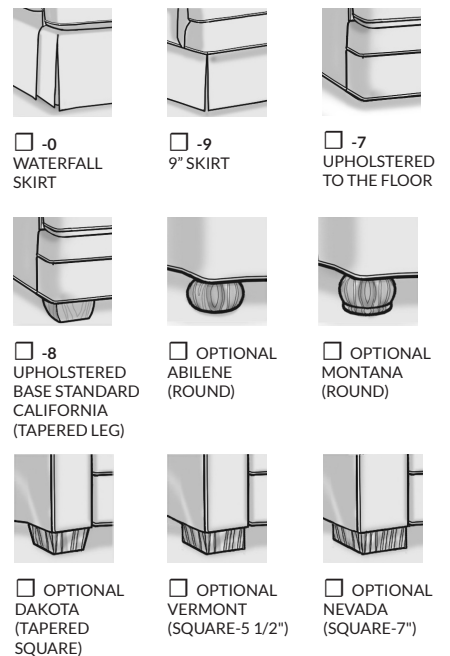

Please print the document at 100% for an accurate scale results.

# TAYLOR MADE: CONTINENTAL

Design your own seating arrangement with Taylor Made. Arrange it to suit your specific needs, and select your favorite back cushion, arm and base styles. In just five easy steps, you have a custom sectional, sofa, loveseat or chair that's uniquely your own.

## STEP 1 CONTINENTAL DEPTH:

CONTINENTAL - DEPTH 44.5"

**SOFA, LOVESEAT AND CHAIRS / SECTIONAL PIECES:**  
 Overall height-38" / Overall depth-44.5"  
 Inside depth-27" / Arm height-24" / Seat height-21.5"  
 19" Throw Pillows. Pillows standard on leather.  
 Upholstered base versions (-7) and (-8) available in leather.  
 1/2" nails are standard on leather.

## STEP 2 CHOOSE YOUR BACK: LOOSE STANDARD / SEMI-ATTACHED OPTIONAL



44 SQUARE BOX BORDER BACK

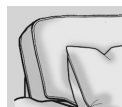

45 ROUND BOX BORDER BACK



46 KNIFE EDGE BORDER BACK



47 BOX BORDER BACK / NO "T" SHAPE

## STEP 3 CHOOSE YOUR SEATING: YOUR CHOICE OF OTTOMAN, CHAIR, LOVESEAT AND SOFA

Quarter Inch Scale Drawing



4500-0 CORRELATING OTTOMAN FOR -38 H20" D23" W31"



4501-0 BUMPER OTTOMAN H21.5" D23" W31"



4502-0 SQUARE BUMPER OTTOMAN H21.5" D29" W29"



4590-0 CORRELATING OTTOMAN FOR -52 H20" D27" W47"



-38 CHAIR W38"

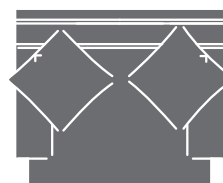

-52 CHAIR & A HALF W52"

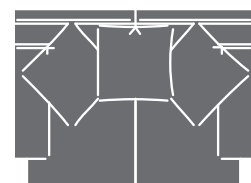

-60 TWO CUSHION LOVESEAT W60"

44.5

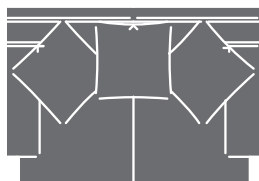

-64 TWO CUSHION LOVESEAT W64"

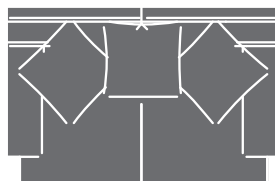

-68 TWO CUSHION LOVESEAT W68"

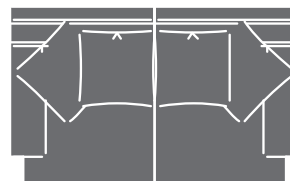

-72 TWO CUSHION MINI SOFA W72"

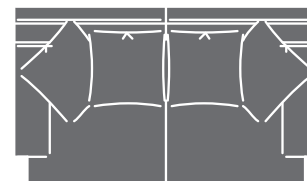

-76 TWO CUSHION MINI SOFA W76"

44.5

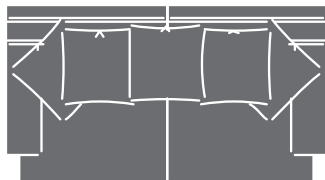

-80 TWO CUSHION SOFA W80"



-84 TWO CUSHION SOFA W84"

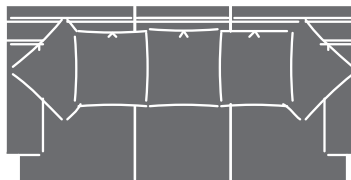

-88 THREE CUSHION SOFA W88"

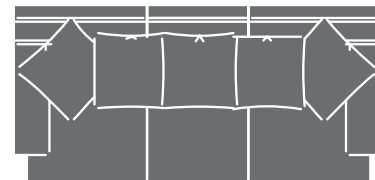

-92 THREE CUSHION SOFA W92"

44.5



-96 THREE CUSHION SOFA W96"

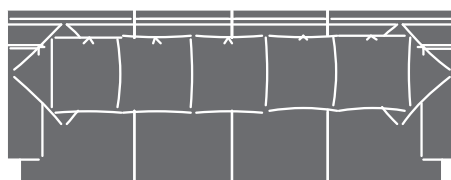

-112 FOUR CUSHION SOFA W112"

44.5

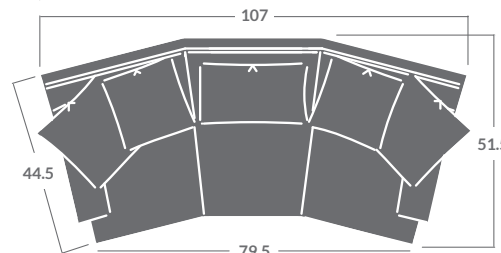

-106 CONVERSATION SOFA W107"

# STEP 3 CHOOSE YOUR SEATING: YOUR CHOICE OF SECTIONAL PIECES

Quarter Inch Scale Drawing



-10  
ARMLESS CHAIR  
W24"



-11  
LEFT ARM CHAIR  
W33"



-12  
RIGHT ARM CHAIR  
W33"



-15  
CORNER CHAIR  
W44.5"



-20  
ARMLESS LOVESEAT  
W48"



4500-2  
CORRELATING OTTOMAN FOR  
-25 QUARTER TURN ONLY  
H20" D32" W53"

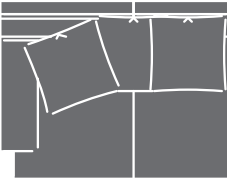

-21  
LEFT ARM LOVESEAT W57"

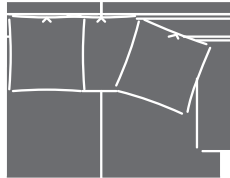

-22  
RIGHT ARM LOVESEAT W57"

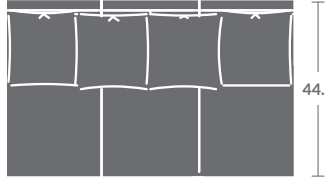

-30  
ARMLESS SOFA W72"



-41  
LEFT ARM  
CHAISE  
W33" D68"



-42  
RIGHT ARM  
CHAISE  
W33" D68"

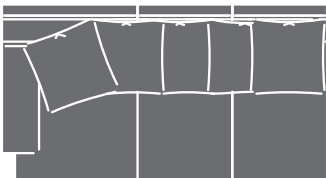

-31  
LEFT ARM SOFA W81.5"

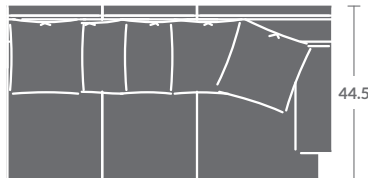

-32  
RIGHT ARM SOFA W81.5"



-45  
LEFT ARM  
CHAISE  
W40" D68"



-46  
RIGHT ARM  
CHAISE  
W40" D68"

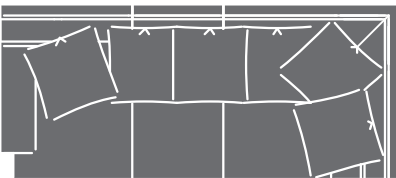

-33  
LEFT ARM CORNER SOFA W100.5"

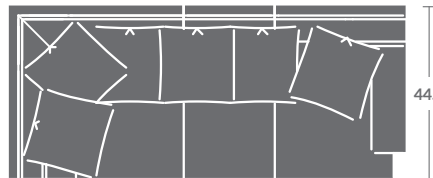

-34  
RIGHT ARM CORNER SOFA W100.5"

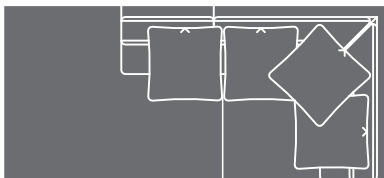

-49  
LEFT OPEN END CORNER SOFA W98"

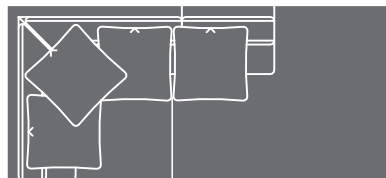

-50  
RIGHT OPEN END CORNER SOFA W98"



-61  
LEFT OPEN END LOVESEAT  
W53.5"



-62  
RIGHT OPEN END LOVESEAT  
W53.5"



# STEP 3 CHOOSE YOUR SEATING: YOUR CHOICE OF SECTIONAL PIECES (continued)

Quarter Inch Scale Drawing

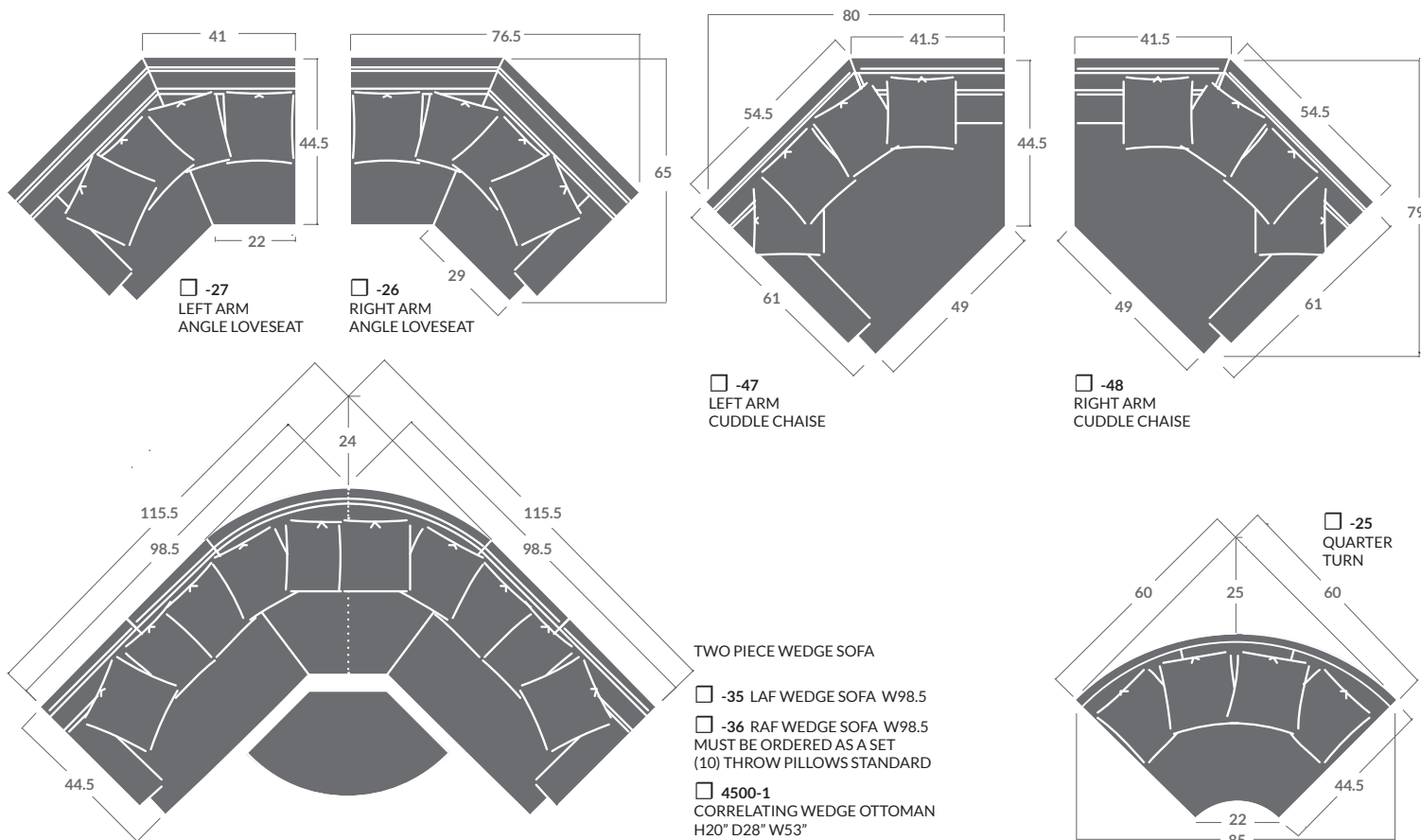

# STEP 4 CHOOSE YOUR ARM:

TRACK ARM - CHAIR 5"/SOFA 6"  
 ENGLISH ARM - CHAIR 6.5"/SOFA 7.5"  
 ALL OTHERS - CHAIR 7.5"/SOFA 8.5"

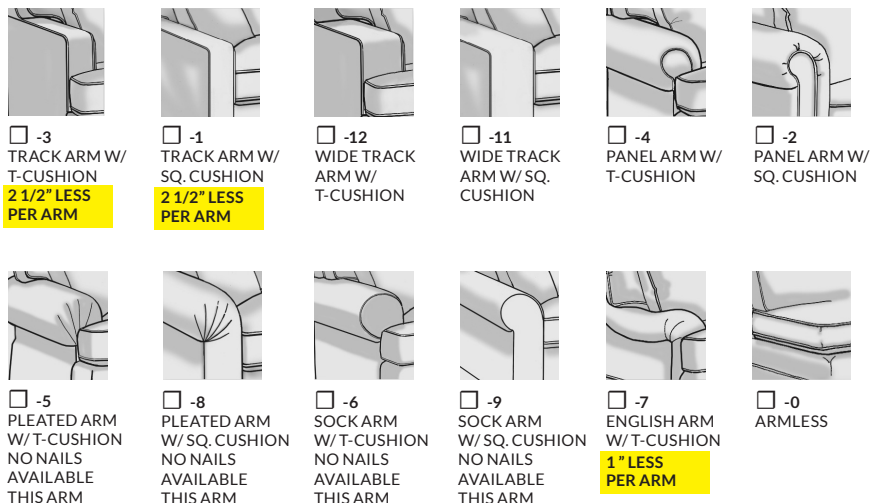

# STEP 5 CHOOSE YOUR BASE STYLE:

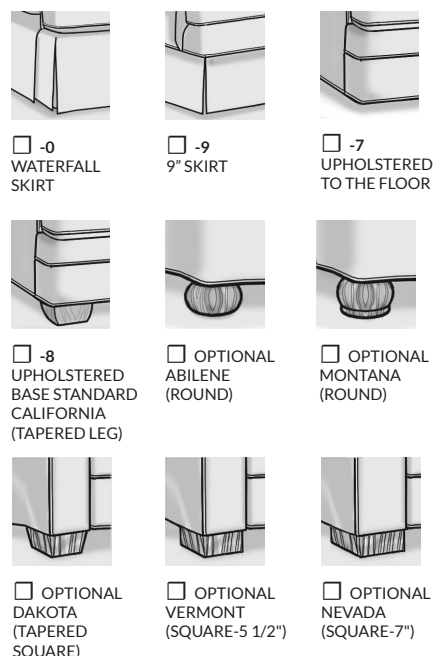

Please print the document at 100% for an accurate scale results.

# TAYLOR MADE: TALL

Design your own seating arrangement with Taylor Made. Arrange it to suit your specific needs, and select your favorite back cushion, arm and base styles. In just five easy steps, you have a custom sectional, sofa, loveseat or chair that's uniquely your own.

## STEP 1 TALL BACK:

TALL - BACK HEIGHT: 40.5"  
OVERALL DEPTH: 42.5"

### SOFA, LOVESEAT AND CHAIRS / SECTIONAL PIECES:

Overall height-40.5" / Overall depth-42.5"  
Inside depth-24" / Arm height-24.5" / Seat height-21.5"  
19" Throw Pillows - Arms & Corners  
21" Throw Pillows - Arms Only  
No pillows standard on leather.  
Upholstered base versions (-7) and (-8) available in leather.  
1/2" nails are standard on leather.

## STEP 2 CHOOSE YOUR BACK: LOOSE STANDARD / SEMI-ATTACHED OPTIONAL



24 SQUARE BOX BORDER BACK



25 ROUND BOX BORDER BACK



26 KNIFE EDGE BORDER BACK

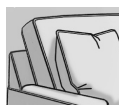

27 BOX BORDER BACK / NO "T" SHAPE

## STEP 3 CHOOSE YOUR SEATING: YOUR CHOICE OF OTTOMAN, CHAIR, LOVESEAT AND SOFA

Quarter Inch Scale Drawing



4500-0 CORRELATING OTTOMAN FOR -38 H20" D23" W31"



4501-0 BUMPER OTTOMAN H21.5" D23" W31"



4502-0 SQUARE BUMPER OTTOMAN H21.5" D29" W29"



4590-0 CORRELATING OTTOMAN FOR -52 H20" D27" W47"



-38 CHAIR W38"

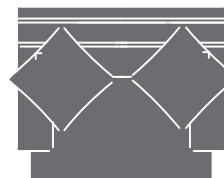

-52 CHAIR & A HALF W52"

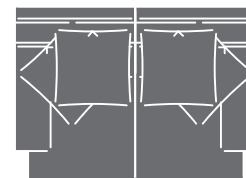

-60 TWO CUSHION LOVESEAT W60"

42.5

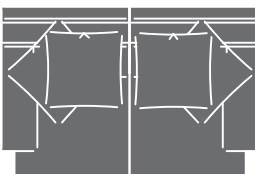

-64 TWO CUSHION LOVESEAT W64"

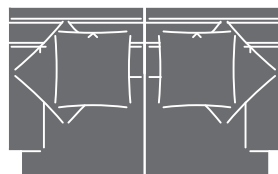

-68 TWO CUSHION LOVESEAT W68"

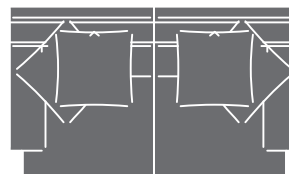

-72 TWO CUSHION MINI SOFA W72"

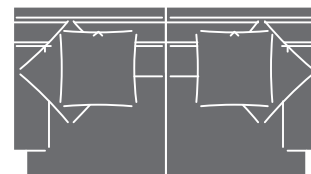

-76 TWO CUSHION MINI SOFA W76"

42.5

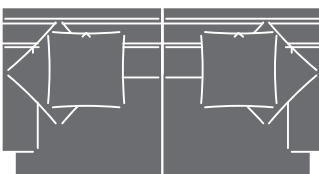

-80 TWO CUSHION SOFA W80"

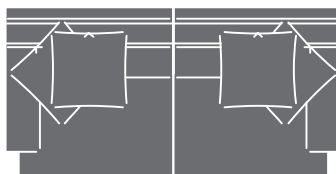

-84 TWO CUSHION SOFA W84"



-88 THREE CUSHION SOFA W88"

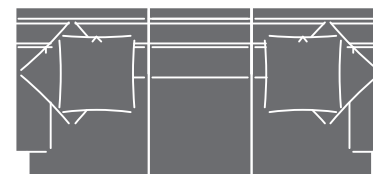

-92 THREE CUSHION SOFA W92"

42.5



-96 THREE CUSHION SOFA W96"



-112 FOUR CUSHION SOFA W112"

42.5

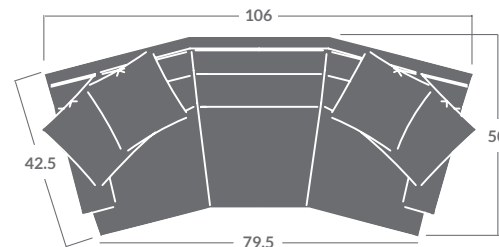

-106 CONVERSATION SOFA W106"

# STEP 3 CHOOSE YOUR SEATING: YOUR CHOICE OF SECTIONAL PIECES

Quarter Inch Scale Drawing



-10  
ARMLESS CHAIR  
W24"



-11  
LEFT ARM CHAIR  
W33"



-12  
RIGHT ARM CHAIR  
W33"



-15  
CORNER CHAIR  
W42.5"



-20  
ARMLESS LOVESEAT  
W48"



4500-2  
CORRELATING OTTOMAN FOR  
-25 QUARTER TURN ONLY  
H20" D32" W53"

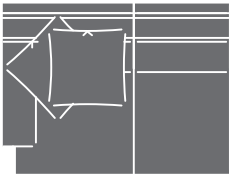

-21  
LEFT ARM LOVESEAT W57"

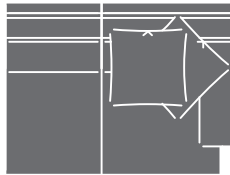

-22  
RIGHT ARM LOVESEAT W57"



-30  
ARMLESS SOFA W72"



-41  
LEFT ARM  
CHAISE  
W33" D66"



-42  
RIGHT ARM  
CHAISE  
W33" D66"

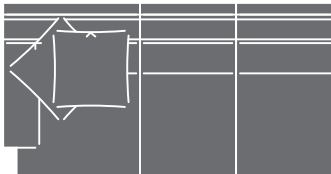

-31  
LEFT ARM SOFA W81.5"

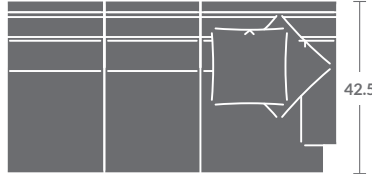

-32  
RIGHT ARM SOFA W81.5"



-45  
LEFT ARM  
CHAISE  
W40" D66"



-46  
RIGHT ARM  
CHAISE  
W40" D66"

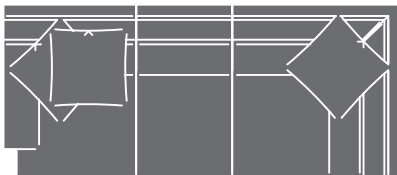

-33  
LEFT ARM CORNER SOFA W98.5"



-34  
RIGHT ARM CORNER SOFA W98.5"



-49  
LEFT OPEN END CORNER SOFA W96"



-50  
RIGHT OPEN END CORNER SOFA W96"



-61  
LEFT OPEN END LOVESEAT  
W53.5"



-62  
RIGHT OPEN END LOVESEAT  
W53.5"

# STEP 3 CHOOSE YOUR SEATING: YOUR CHOICE OF SECTIONAL PIECES (continued)

Quarter Inch Scale Drawing

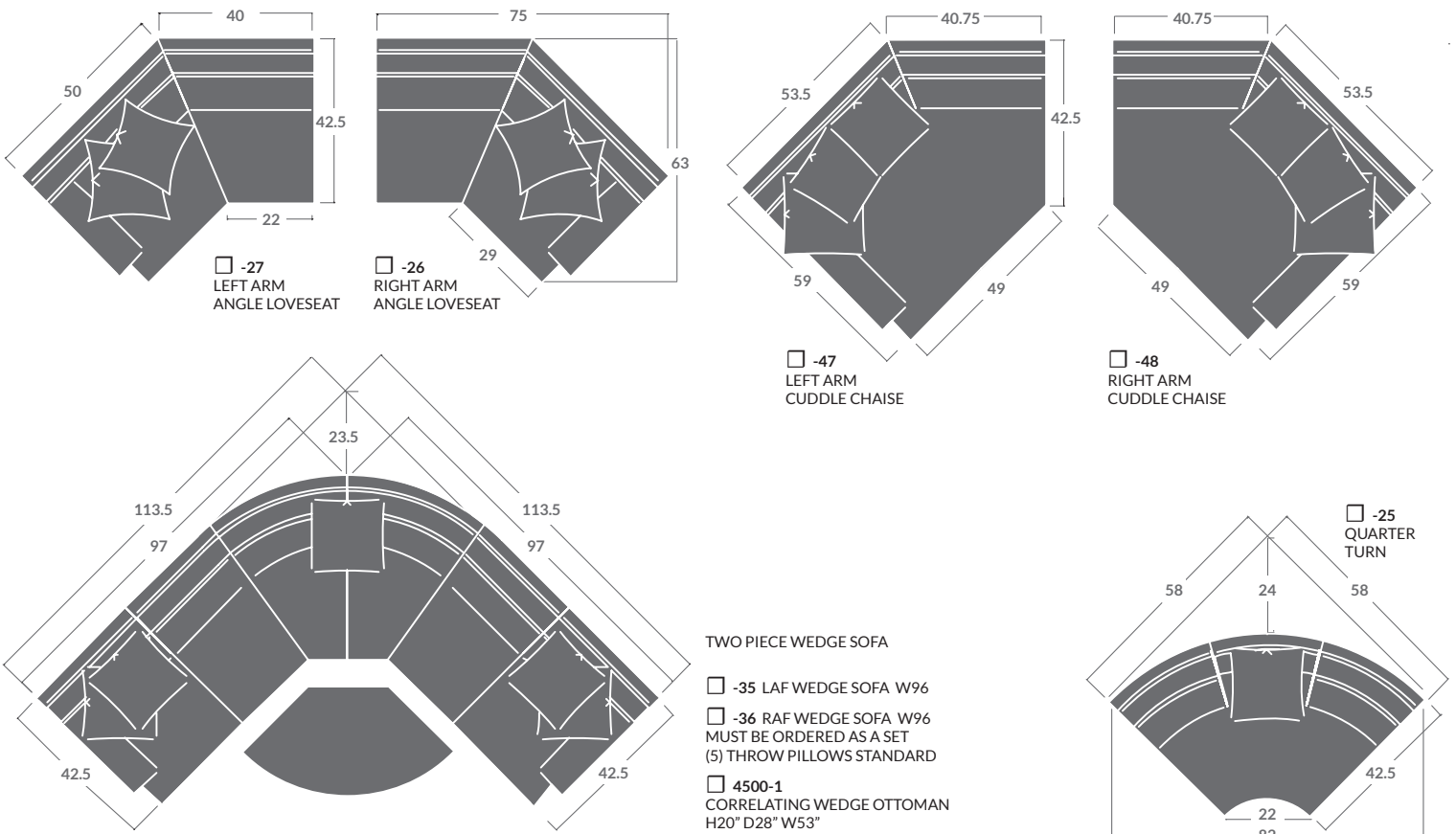

# STEP 4 CHOOSE YOUR ARM:

TRACK ARM - CHAIR 5"/SOFA 6"  
 ENGLISH ARM - CHAIR 6.5"/SOFA 7.5"  
 ALL OTHERS - CHAIR 7.5"/SOFA 8.5"

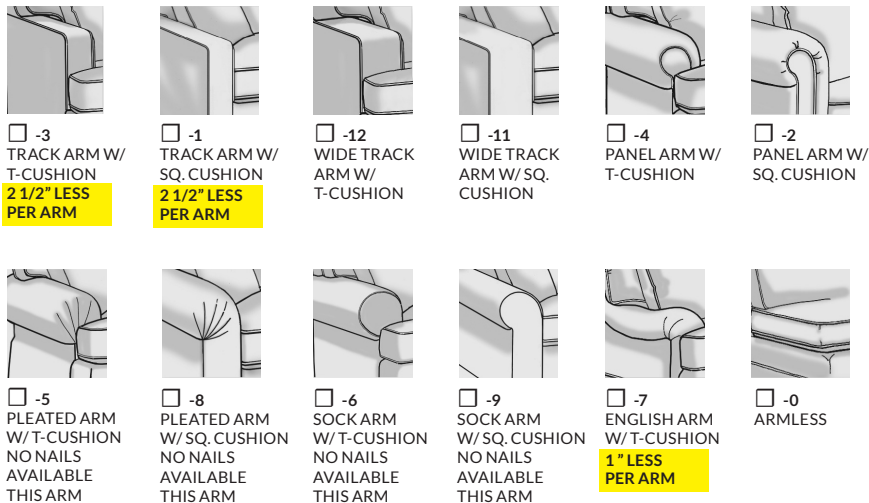

# STEP 5 CHOOSE YOUR BASE STYLE:

